

Tragfähigkeit

1000 kg

Flanschbreite

64 mm - 125 mm

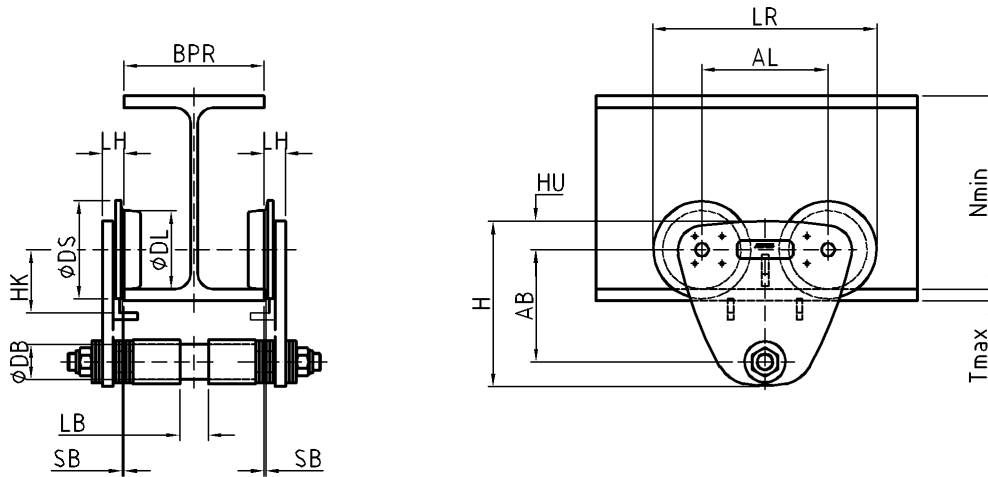

Maße und Gewichte

AL	150 mm	AB	125 mm	DS	100 mm		
DL	80 mm	DB	34 mm	HU	41 mm		
H	193 mm	HK	71 mm	LR	250 mm	N _{min}	130 mm
LB	33 mm	LH	22 mm				
SB _{max}	2 mm	T _{max}	25 mm				

Gewicht Fahrwerk 11,0 kg

BPR _{min}	BPR _{max}	Kurvenradius
64 mm	90 mm	>= 1100 mm
91 mm	125 mm	>= 1500 mm

ABUS Kransysteme GmbH
 Sonnenweg 1
 51647 Gummersbach

Fahrwerk HF14

30.10.2012